

# Symmetry, Geometry, and Topological Phases

Taylor L. Hughes

University of Illinois at Urbana Champaign

**NHMFL Winter School Lecture**

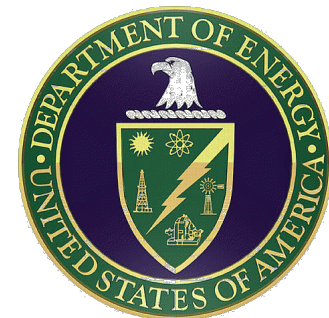

# Outline

Part 1: Topological phases and response protected by discrete translation, inversion, and rotation symmetries

Part 2: Bound states on geometric defects in point-group protected topological phases

Part 3: Response of a time-reversal breaking, free-fermion topological phase to geometric deformations

# Part 1: Topological Phases and Response Protected by Discrete Spatial Symmetries

# Historical Reference List

## Precursor of Spatial-Symmetry Protected Topological Phases:

- Zak, J. "Berry's phase for energy bands in solids." *Physical review letters* **62**, 2747 (1989).  
-Wannier center locations are quantized in inversion symmetric crystals, i.e., polarization is quantized.

## Modern Inception of Field:

- Fu, L., Kane, C. L., & Mele, E. J. (2007). Topological insulators in three dimensions. *Physical review letters*, *98*(10), 106803.
- Moore, J. E., and Leon Balents. "Topological invariants of time-reversal-invariant band structures." *Physical Review B* *75*.12 (2007): 121306.  
-Introduction of weak topological insulators protected by time-reversal and translation symmetry.
- Fu, Liang, and Charles L. Kane. "Topological insulators with inversion symmetry." *Physical Review B* **76**, 045302 (2007).  
-TIs with time-reversal and inversion symmetry are classified in 2D and 3D. First discrete eigenvalue formula.
- Teo, Jeffrey CY, Liang Fu, and C. L. Kane. "Surface states and topological invariants in three-dimensional topological insulators: Application to  $\text{Bi}_{1-x}\text{Sb}_x$ ." *Physical Review B*, **78**, 045426 (2008).  
-Introduction of mirror Chern number in 3D materials. Call for a complete topological band theory including all point-group symmetries.

# Historical Reference List

## Resulting Classification:

- Fu, Liang. "Topological crystalline insulators." *Physical Review Letters* 106.10 (2011): 106802.
- Hughes, Taylor L., Emil Prodan, and B. Andrei Bernevig. "Inversion-symmetric topological insulators." *Physical Review B* 83.24 (2011): 245132.
- Turner, Ari M., et al. "Quantized response and topology of magnetic insulators with inversion symmetry." *Physical Review B* 85.16 (2012): 165120.
- Fang, Chen, Matthew J. Gilbert, and B. Andrei Bernevig. "Bulk topological invariants in noninteracting point group symmetric insulators." *Physical Review B* 86.11 (2012): 115112.
- Jadaun, Priyamvada, et al. "Topological classification of crystalline insulators with space group symmetry." *Physical Review B* 88.8 (2013): 085110.
- Slager, Robert-Jan, et al. "The space group classification of topological band-insulators." *Nature Physics* 9.2 (2012): 98-102.
- Teo, Jeffrey CY, and Taylor L. Hughes. "Existence of Majorana-Fermion Bound States on Disclinations and the Classification of Topological Crystalline Superconductors in Two Dimensions." *Physical review letters* 111.4 (2013): 047006.
- Chiu, Ching-Kai, Hong Yao, and Shinsei Ryu. "Classification of topological insulators and superconductors in the presence of reflection symmetry." *Phys. Rev. B* **88**, 075142 (2013).
- Zhang, Fan, C. L. Kane, and E. J. Mele. "Topological Mirror Superconductivity." *Phys. Rev. Lett.* **111**, 056403 (2013).

## Material Prediction and Experimental Confirmations

- Hsieh, Timothy H., et al. "Topological crystalline insulators in the SnTe material class." *Nat. Comm.* **3**, 982 (2012).
- Tanaka, Y., et al. "Experimental realization of a topological crystalline insulator in SnTe." *Nat. Phys.* **8**, 800 (2012).
- Dziawa, P., et al. "Topological crystalline insulator states in  $\text{Pb}_{1-x}\text{Sn}_x\text{Se}$ ." *Nat. Mat.* **11**, 1023 (2012).
- Xu, Su-Yang, et al. "Observation of a topological crystalline insulator phase and topological phase transition in  $\text{Pb}_{1-x}\text{Sn}_x\text{Te}$ ." *Nat. Com.* **3**, 1192 (2012).

# Periodic Table of Free Fermion Topological Phases

Dim/Symmetry	C, $\tilde{T}$	C (D)	C, T	T	T, $\check{C}$	$\check{C}$	$\check{C}, \tilde{T}$	$\tilde{T}$	$\theta$	$\chi$
(0+1)d	$Z_2$	$Z_2$	0	Z	0	0	0	Z	Z	0
(1+1)d	Z	$Z_2$	$Z_2$	0	Z	0	0	0	0	Z
(2+1)d	0	Z	$Z_2$	$Z_2$	0	Z	0	0	Z	0
(3+1)d	0	0	Z	$Z_2$	$Z_2$	0	Z	0	0	Z
(4+1)d	0	0	0	Z	$Z_2$	$Z_2$	0	Z	Z	0
(5+1)d	Z	0	0	0	Z	$Z_2$	$Z_2$	0	0	Z
(6+1)d	0	Z	0	0	0	Z	$Z_2$	$Z_2$	Z	0
(7+1)d	$Z_2$	0	Z	0	0	0	Z	$Z_2$	0	Z

The non-zero entries represent “strong” topological invariants of the bulk that distinguish gapped phases from a trivial atomic limit.

Does not include unitary symmetries. Important to consider spatial symmetries such as translation, reflection, (discrete) rotation.

Schnyder, Ryu, Furusaki, Ludwig: PRB (2008)  
 Kitaev: Adv. in Theoretical Phys. 2009  
 Qi, Hughes, Zhang: PRB(2008)

# Example: Su-Schrieffer-Heeger model in 1D

Class D insulator in 1+1-d with (fine-tuned) particle-hole symmetry. Strong invariant:  $Z_2$ .

Given:  $H(k) \ni CH(k)C^{-1} = -H^T(-k)$

Construct:  $A^{mn}(k) = -i\langle u_m(k) | \partial_k | u_n(k) \rangle$

Calculate:  $\theta = \int_{-\pi/a}^{\pi/a} dk \text{Tr} [A(k)]$

$\Theta=0$



$\Theta=\pi$



# Electromagnetic Response in 1D

$\Theta=0$



$\Theta=\pi$



Connection between topological invariant and EM response—the charge polarization.

$$P_1 = \frac{e\theta}{2\pi} \text{ mod } Ze$$

At half filling there are bound charges on the ends when  $\theta=\pi$  which illustrate the bulk charge polarization. Example of a connection between a ‘strong’ topological invariant and an observable.



# Weak Invariants due to Translation Symmetry

Preserving translation invariance introduces a new series of invariants generically called “weak” topological invariants.

Dim/Symmetry	C	C & Translation	Invariants
(0+1)d	$Z_2$	$Z_2$	$G_0$
(1+1)d	$Z_2$	$Z_2 + Z_2$	$G + G_0$
(2+1)d	$Z$	$Z + 2Z_2 + Z_2$	$G + G_a + G_0$
(3+1)d	0	$0 + 3Z + 3Z_2 + Z_2$	$0 + G_a + G_{ab} + G_0$
...	...	...	...

While strong invariants are isotropic, the weak invariants are anisotropic.

K-theory classification on torus instead of sphere

Strong + **Weak** + Secondary Weak + **Global Electromagnetic**

# Example: Weak Invariants from SSH

Class D in 2d:  $\mathbb{Z} + 2\mathbb{Z}_2$

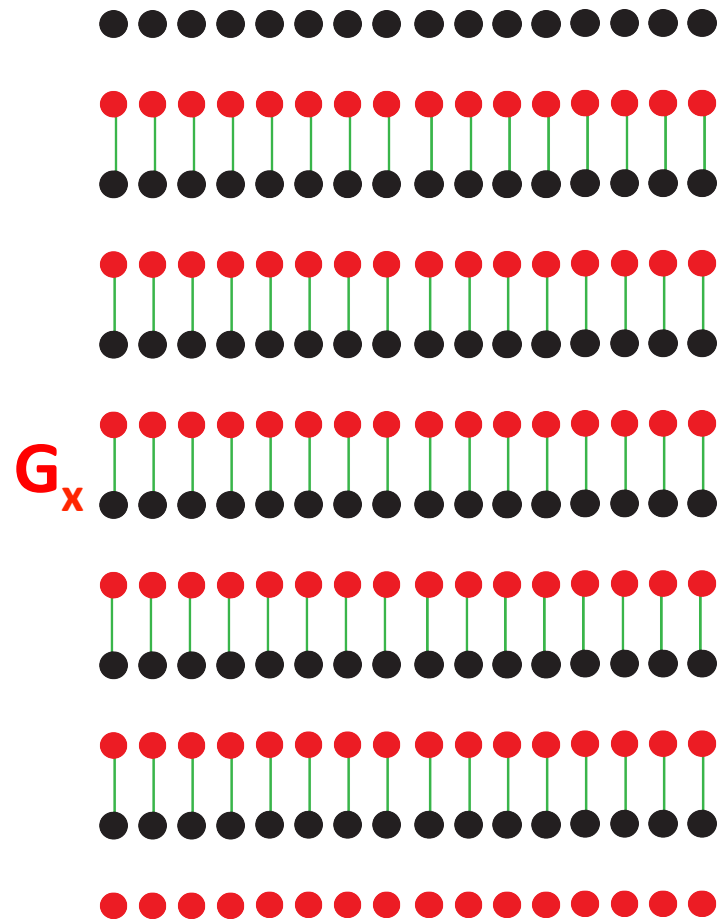
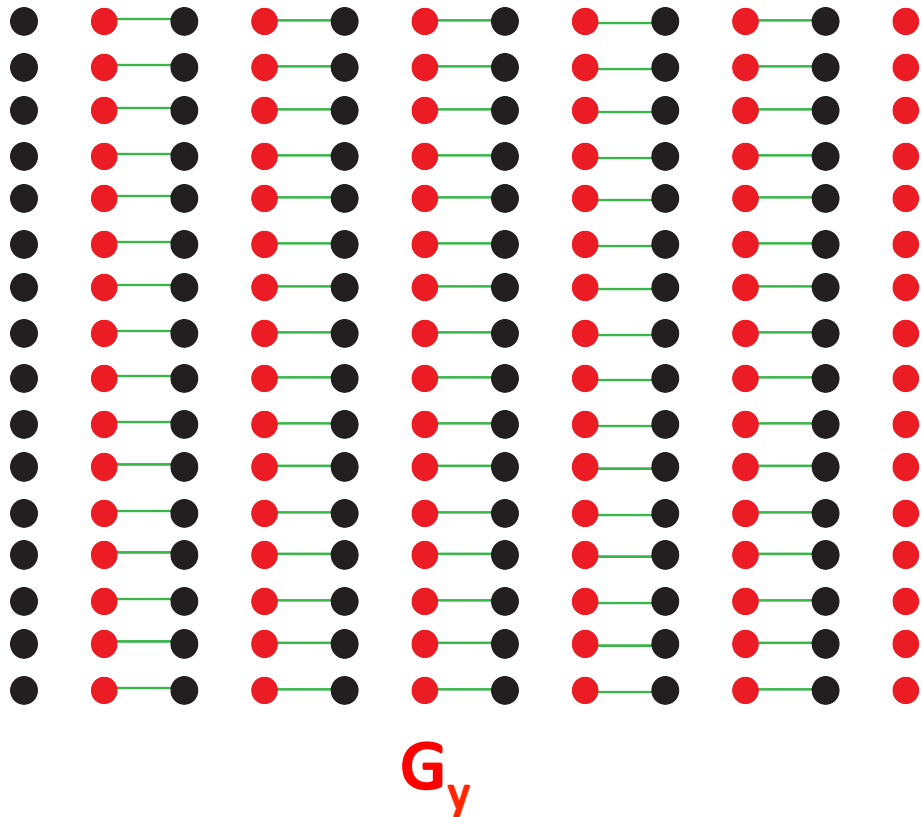

# Weak vs. Strong in 2D

Class D in 2d:  $\mathbb{Z} + 2\mathbb{Z}_2$

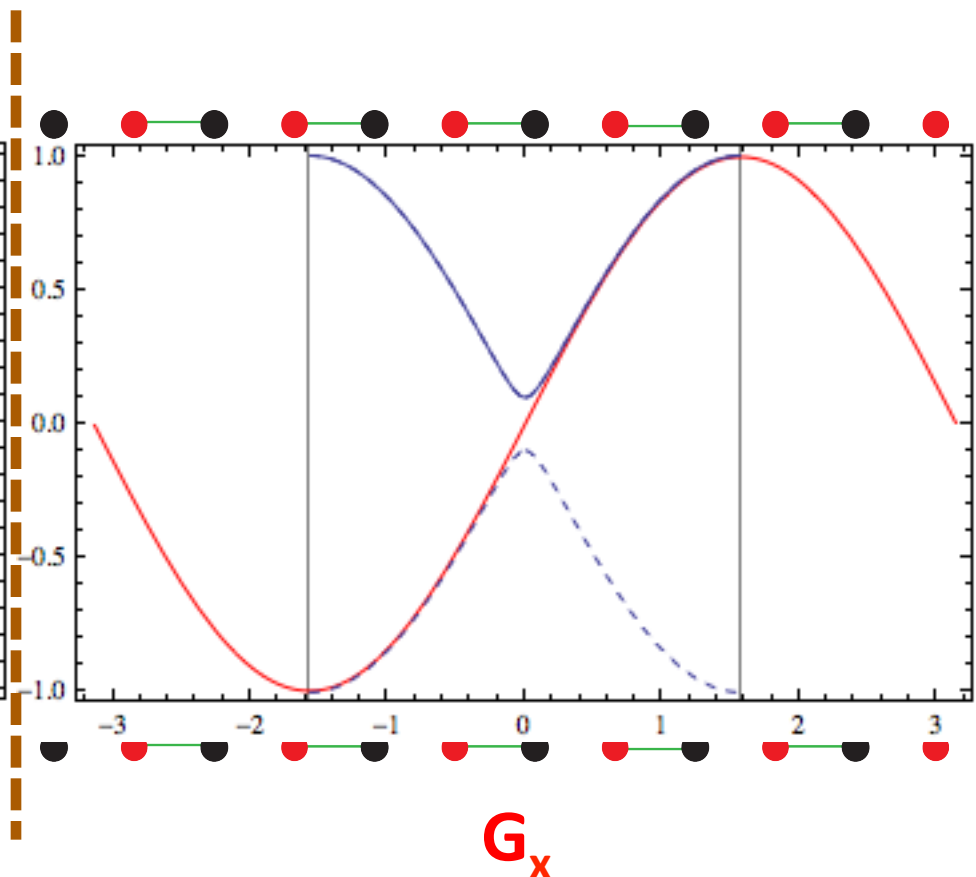
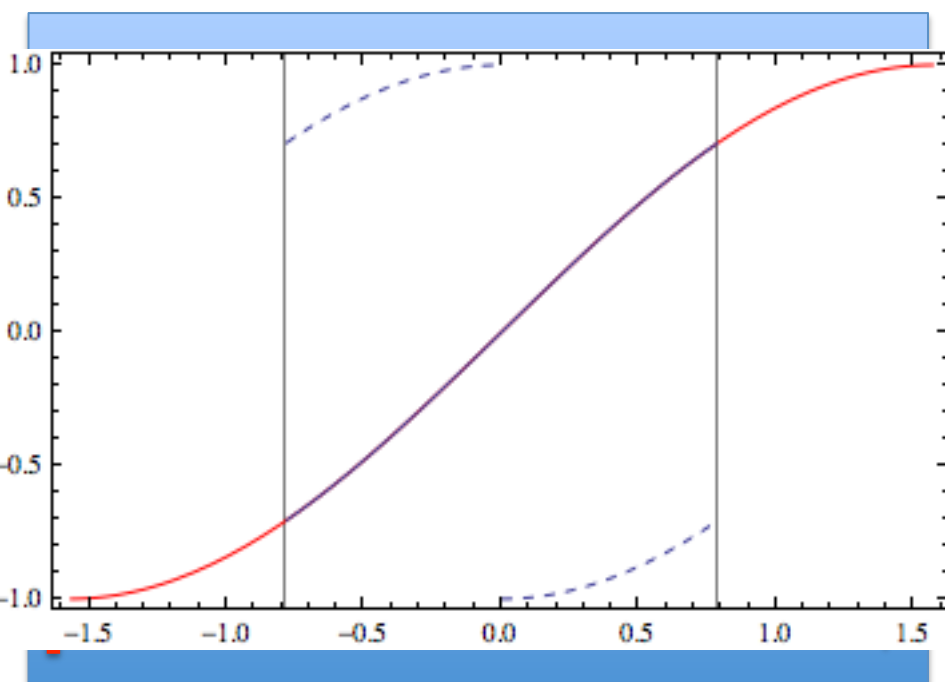

First Chern Number:  $C_1$

If only the weak invariant is non-zero, breaking translation symmetry (even just on the edge) allows us to gap the system!

# Electromagnetic Response Actions

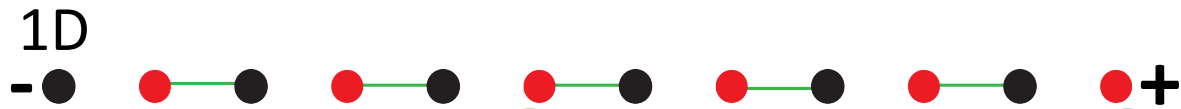

$$S_1[A_\mu] = \frac{e}{4\pi} \int dx dt \theta \epsilon^{\mu\nu} F_{\mu\nu} = \int dx dt P_1 E$$

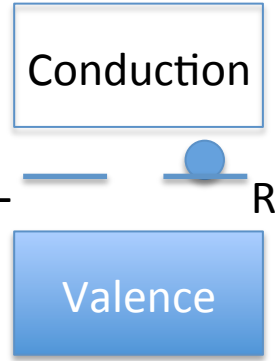

2D (weak)

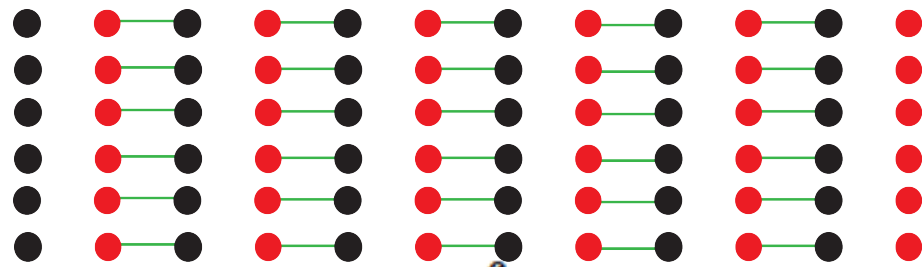

$$S_2[A_\mu] = \frac{e}{8\pi^2} \int d^2x dt G_i \epsilon^{i\mu\nu} F_{\mu\nu} = \int d^2x dt \mathbf{P}_1 \cdot \mathbf{E}$$

2D (strong)



$$S_{CS}[A_\mu] = \frac{e^2}{4h} \int d^2x dt A_\mu \epsilon^{\mu\nu\rho} F_{\nu\rho}$$

# Quantization of $Z_2$ Electromagnetic Response

$$S_1[A_\mu] = \frac{e}{4\pi} \int dxdt \theta \epsilon^{\mu\nu} F_{\mu\nu} = \int dxdt P_1 E$$

$Z_2$  Quantization of  $P_1$ :

- Under C symmetry  $P_1$  transforms to  $-P_1$  (odd). This constrains  $P_1 = -P_1$ .
- For crystals  $P_1$  is periodic i.e.  $P_1 = P_1 + ne$
- $P_1 = 0$  or  $e/2$

This type of quantized response appears in all even spacetime dimensions

$$S_3[A_\mu] = \int d^3xdt P_3 \mathbf{E} \cdot \mathbf{B} \quad (\text{odd under } T, T^2 = -1)$$

$$S_5[A_\mu] = \int d^5xdt P_5 E_{01} B_{23} B_{45} \quad (\text{odd under } C, C^2 = -1)$$

$$S_7[A_\mu] = \int d^7xdt P_7 E_{01} B_{23} B_{45} B_{67} \quad (\text{odd under } T, T^2 = +1)$$

Interestingly, *every* action has an  $\mathbf{E}$ -field, thus also odd under inversion!

# Inversion Protected Topological Phases

Each of the topological phases with a generalized polarization response can be stabilized by inversion symmetry instead of C or T. Thus, can arise in non-fine tuned/non-superconducting systems ( $\mathbb{C}$ ) and in magnetic systems ( $\mathbb{F}$ ). We will only consider a tiny subset of the rich inversion protected classification.

Big calculational advantage is that topological invariants in models can be determined from discrete data in the Brillouin zone without any integration.

Example:  $PH(k)P^{-1} = H(-k)$

$$P_1 = \frac{e}{2\pi i} \text{Log} \left( \frac{\det B(\pi/a)}{\det B(0)} \right) = \frac{e}{2\pi i} \text{Log} \left( \prod_{a \in occ.} \zeta(\pi/a) \zeta(0) \right)$$

$$\text{Tr}[A(-k)] = -\text{Tr}[A(k)] - i\nabla_k \text{Log}[\det B(k)]$$

$$B_{mn}(k) \equiv \langle u_m(-k) | P | u_n(k) \rangle$$

If we know the inversion eigenvalues of the occupied bands we can determine polarization.

# Inversion Eigenvalue Example

$\Theta=0$

$$P = \sigma^x$$

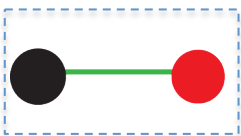

$$H(k) = \begin{pmatrix} 0 & -t \\ -t & 0 \end{pmatrix} \quad A(k) = 0$$

$$\zeta(k=0) = \zeta(k=\pi/a) = +1$$

$\Theta=\pi$



$$H(k) = \begin{pmatrix} 0 & -te^{ika} \\ -te^{-ika} & 0 \end{pmatrix} \quad A(k) = \frac{1}{2}$$

$$\zeta(k=0) = -\zeta(k=\pi/a) = +1$$

# Higher Dimensional Cases with Inversion

2D:

Chern  
Number

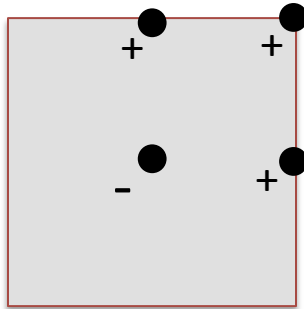

$$(-1)^{C_1} = \prod_{\Lambda, \alpha \in occ.} \zeta_{\alpha}(k = \Lambda)$$

Inversion( $C_2$ ) determines Chern number mod 2 (Hughes et al., Turner et al.)  
 $C_n$  rotation determines Chern number mod n (Fang et al.)

3D:

Magneto-  
electric  
polarization

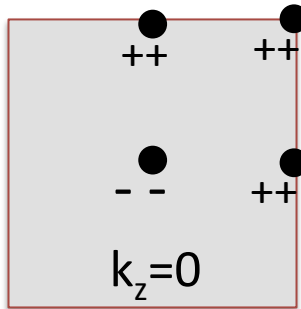

$$S_3[A_{\mu}] = \int d^3x dt P_3 \mathbf{E} \cdot \mathbf{B}$$

With T and P we can use the Fu-Kane formula:

$$P_3 = \prod_{\Lambda, \alpha \in occ./2} \zeta_{\alpha}(k = \Lambda)$$

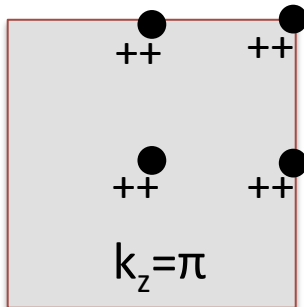

Eigenvalues come in Kramers' pairs with T & P.  
 But if we break T, how do we choose half the occupied states?



# Higher Dimensional Cases with Inversion

3D:

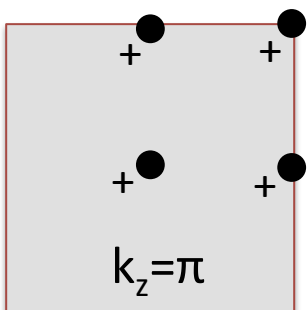
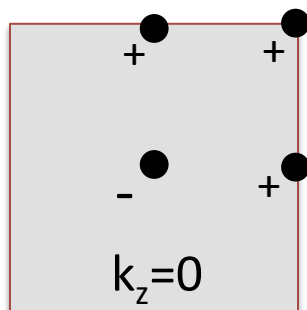

To make the formula well defined when we only have P there must be constraints so that we can define half the occupied bands when there is no Kramers' degeneracy:

- Topological constraint: Product of ALL inversion eigenvalues must be positive (otherwise gapless). If product is negative there exists a topologically protected metal (Weyl semi-metal in some cases)
- All first Chern numbers vanish (or are even)

$$P_3 = \prod_{\Lambda, \alpha \in occ./2} \zeta_{\alpha}(k = \Lambda)$$

Chern number has to go from odd to even as  $k_z$  goes from 0 to  $\pi$ . This cannot happen in an insulator.

# Part 2: Bound States on Topological Defects in Spatial Symmetry Protected Phases

# Historical Reference List

## Precursors:

- Jackiw, R., and C. Rebbi. "Solitons with fermion number  $1/2$ ." *Phys. Rev. D* 13.12 (1976): 3398-3409.
- Su, W. P., J. R. Schrieffer, and A. J. Heeger. "Solitons in polyacetylene." *Physical Review Letters* 42.25 (1979): 1698-1701.

## Modern Developments:

- Lee, Dung-Hai, Guang-Ming Zhang, and Tao Xiang. "Edge solitons of topological insulators and fractionalized quasiparticles in two dimensions." *Physical review letters* 99.19 (2007): 196805.
- Ran, Ying, Ashvin Vishwanath, and Dung-Hai Lee. "Spin-Charge Separated Solitons in a Topological Band Insulator." *Physical review letters* 101.8 (2008): 086801.
- Qi, Xiao-Liang, and Shou-Cheng Zhang. "Spin-Charge Separation in the Quantum Spin Hall State." *Physical Review Letters* 101.8 (2008): 086802.
- Ran, Ying, Yi Zhang, and Ashvin Vishwanath. "One-dimensional topologically protected modes in topological insulators with lattice dislocations." *Nature Physics* 5.4 (2009): 298-303.
- Juričić, Vladimir, et al. "Universal Probes of Two-Dimensional Topological Insulators: Dislocation and  $\pi$  Flux." *Physical Review Letters* 108.10 (2012): 106403.
- Hughes, Taylor, Hong Yao, and Xiao-Liang Qi. "Majorana Fermions Bound to Dislocations in 2d Weak Topological Superconductors." *Bulletin of the American Physical Society* 55 (2010).
- Teo, Jeffrey CY, and Taylor L. Hughes. "Existence of Majorana-Fermion Bound States on Disclinations and the Classification of Topological Crystalline Superconductors in Two Dimensions." *Physical review letters* 111.4 (2013): 047006.
- Benalcazar, Wladimir A., Jeffrey CY Teo, and Taylor L. Hughes. "Classification of Two Dimensional Topological Crystalline Superconductors and Majorana Bound States at Disclinations." *arXiv preprint arXiv:1311.0496* (2013).

# 2+1-d Topological Insulator (QAHE)

Take massive Dirac Hamiltonian in 2+1-d (Haldane 1988). Also known as Chern Insulator.

$$H_{2d} = \sum_k c_k^\dagger (k_x \sigma^x + k_y \sigma^y + m \sigma^z) c_k$$

$$E_{\pm} = \pm \sqrt{k_x^2 + k_y^2 + m^2}$$

edge

Vacuum  
 $m > 0$

Bulk  
 $m < 0$

$$= \sum_k c_k^\dagger \begin{pmatrix} m & k_x - ik_y \\ k_x + ik_y & -m \end{pmatrix} c_k$$

Bulk described by massive Dirac fermions, boundary described by massless chiral fermions in one lower dimension, Clifford algebra dimension cut in half. QHE without Landau levels.

# Boundstate Production Mechanisms

For free fermion models the Dirac domain wall/vortex is the generic mechanism for topological boundstates. However, this does not apply for more complicated interacting systems.

Another mechanism which can be used even with interactions are considering “gauge fluxes” of a global symmetry.

Symmetry	Flux
U(1) Global Charge Conservation	Magnetic flux
Translation Symmetry	Dislocation
Rotation Symmetry	Disclination
Anyonic Symmetry	Twist Defect

In the case of free fermions the mechanisms coincide

# Bound States on a flux in the QAHE/Chern Insulator

Topological Phase Protected by Global U(1) symmetry: global charge conservation

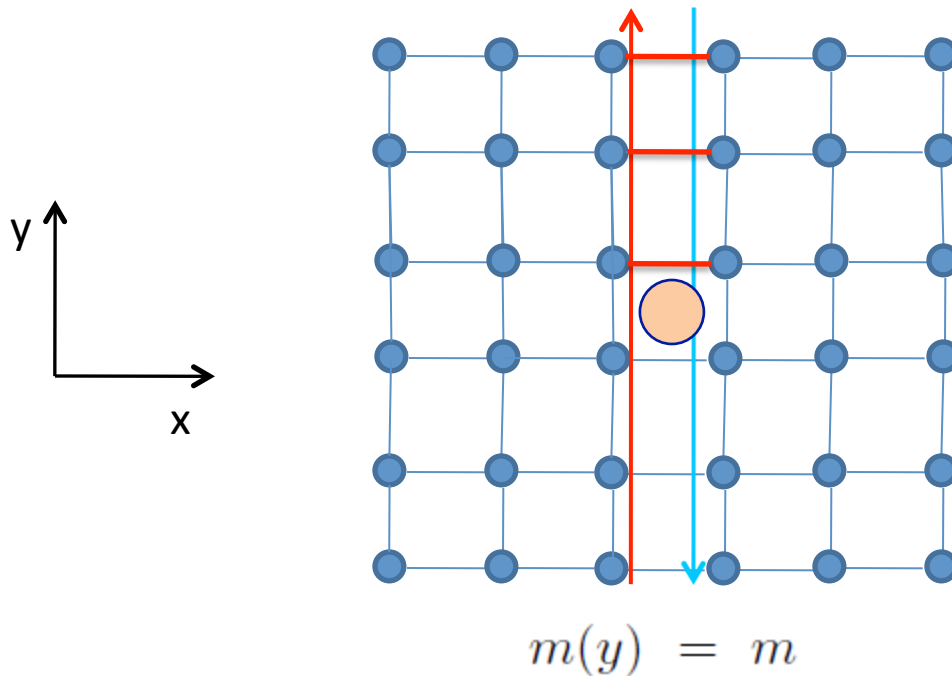

Gapless fermion spectrum on cut

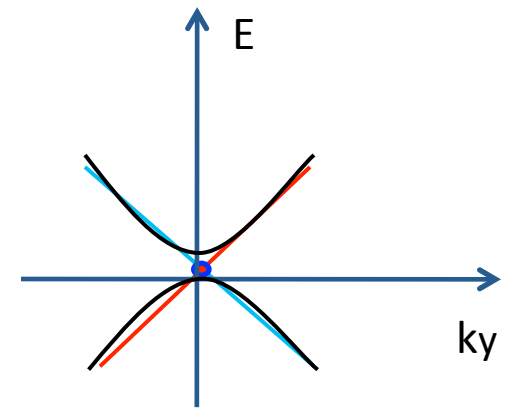

$$H = \begin{pmatrix} p_y & m(y) \\ m(y) & -p_y \end{pmatrix}$$

# Crystal Dislocations: Translation/Torsion Flux

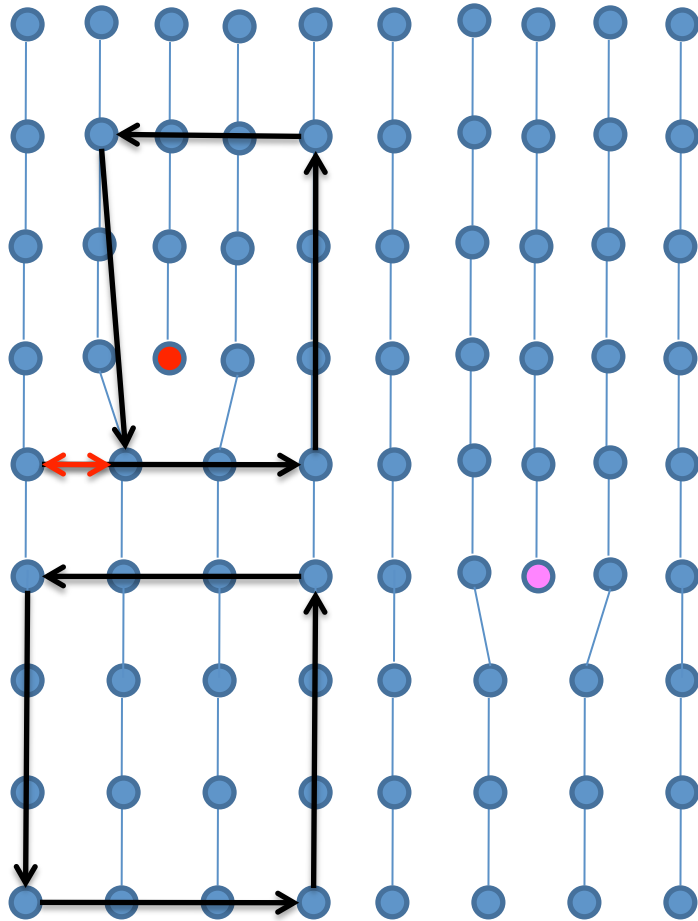

Let's take a path in the lattice  
3 steps right  
3 steps up  
3 steps left  
3 steps down  
This path is closed in the  
reference state.

The amount of translation is the  
Burgers vector and it is a vector of  
topological charges. It doesn't change  
if you continuously deform the  
dislocation.

# Dislocation Bound States in Translation Protected Topological States

Topological insulators/  
superconductors (class D)  
with weak indices  
 $(G_1, G_2, G_3) = \mathbf{G}_c$

$$n = \frac{1}{2\pi} \mathbf{G}_c \cdot \mathbf{B}$$

Burger's vector  
characterizing  
dislocation

Ran, Zhang,  
Vishwanath, 2009

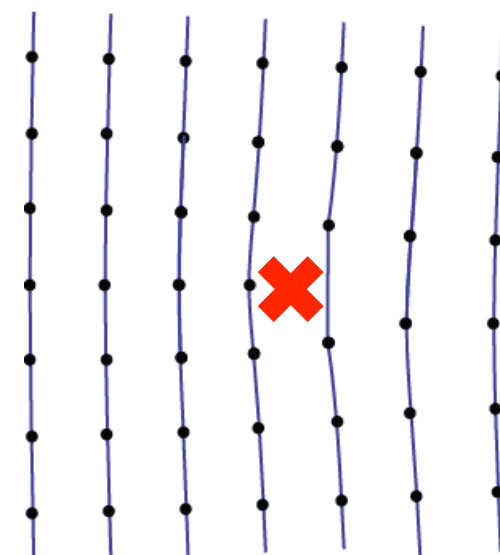
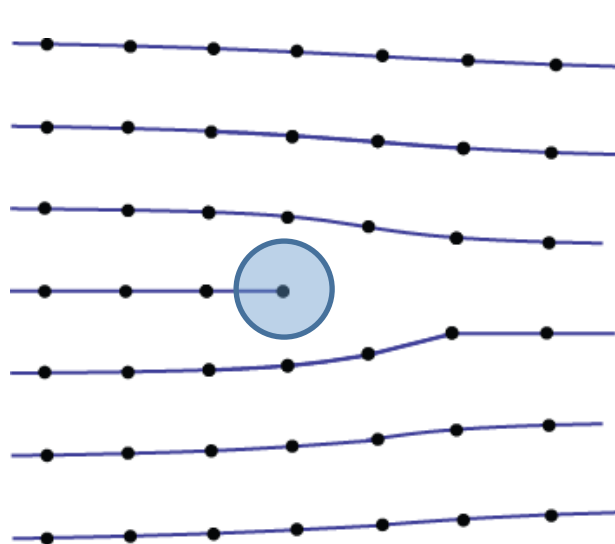
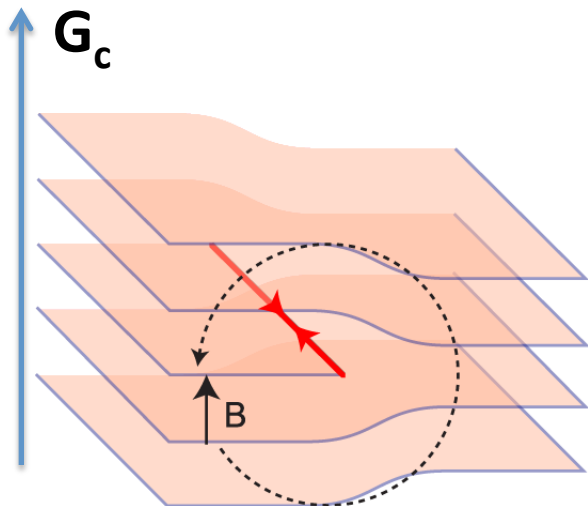



# Bound States on Dislocations

$$m(y) = m e^{i\mathbf{b}\cdot\mathbf{K}}$$

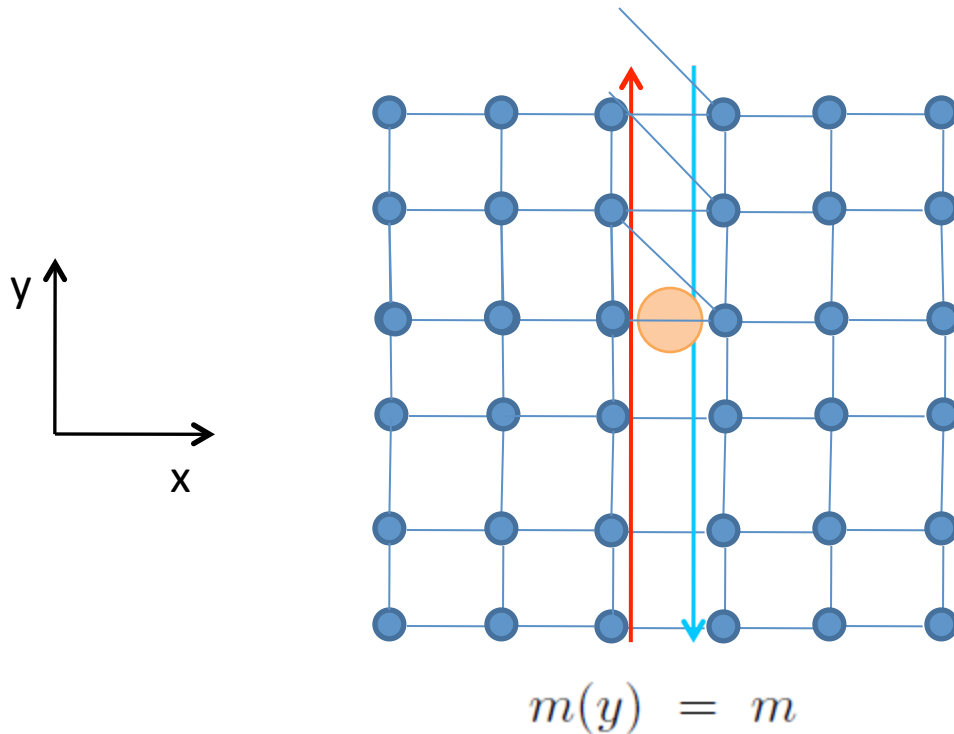

Gapless fermion spectrum on cut

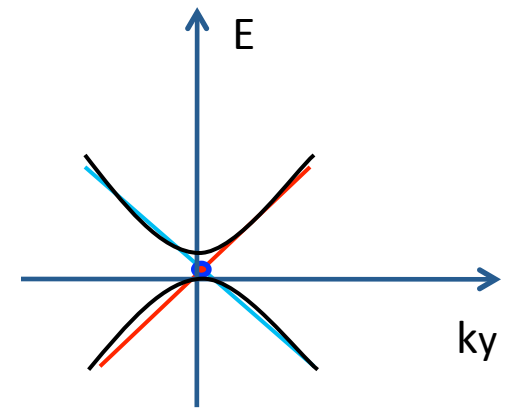

$$H = \begin{pmatrix} p_y & m(y) \\ m(y) & -p_y \end{pmatrix}$$

# Bound States with Secondary Weak Invariants

In class D in 3d we have an antisymmetric tensor  $\mathbf{G}_{ab}$

$$n = \frac{1}{2\pi} G_{ab} B^a \tau^b$$

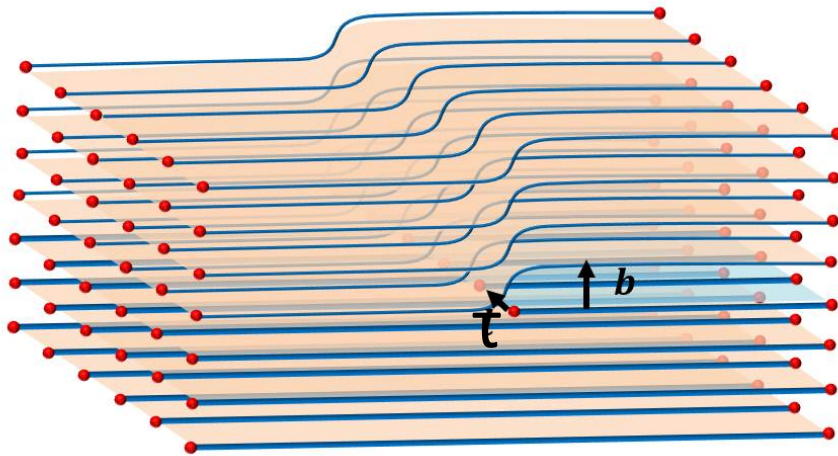

Requires translation symmetry along dislocation.  
A weak invariant for the dislocation itself!

$$n = \frac{1}{2\pi} G_{ab} B_1^a B_2^b$$

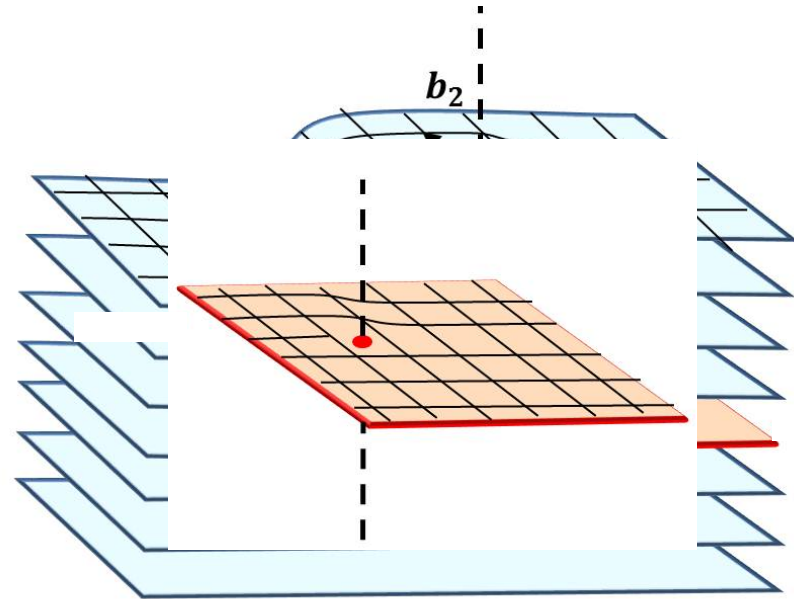

Bound state on linked dislocations does not require symmetry along dislocation.  
Possible appearance in Raghu, Kapitulnik, Kivelson state of  $\text{Sr}_2\text{RuO}_4$  where  $G_{ab} \neq 0$ .

# Disclinations in the Square Lattice

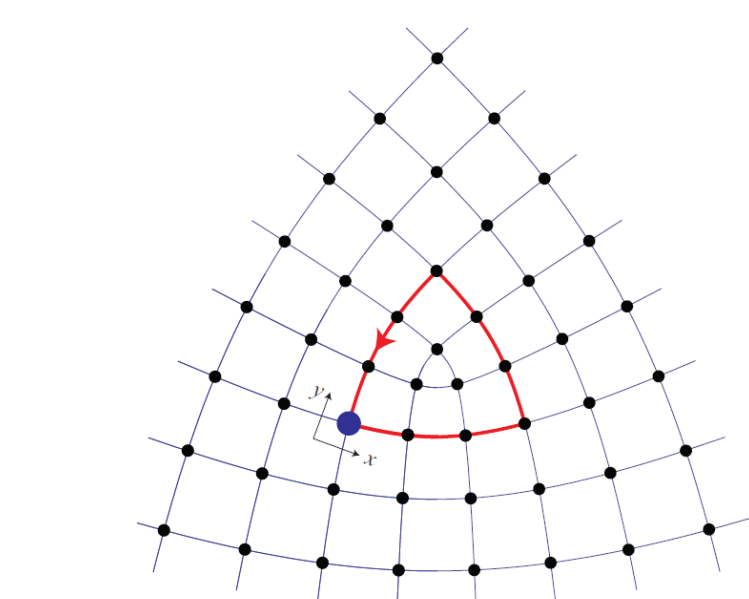

$$r(\mathbf{e}_x)^3 r(\mathbf{e}_x)^3 r(\mathbf{e}_x)^3 = (-3\mathbf{e}_x)r^{-1}$$

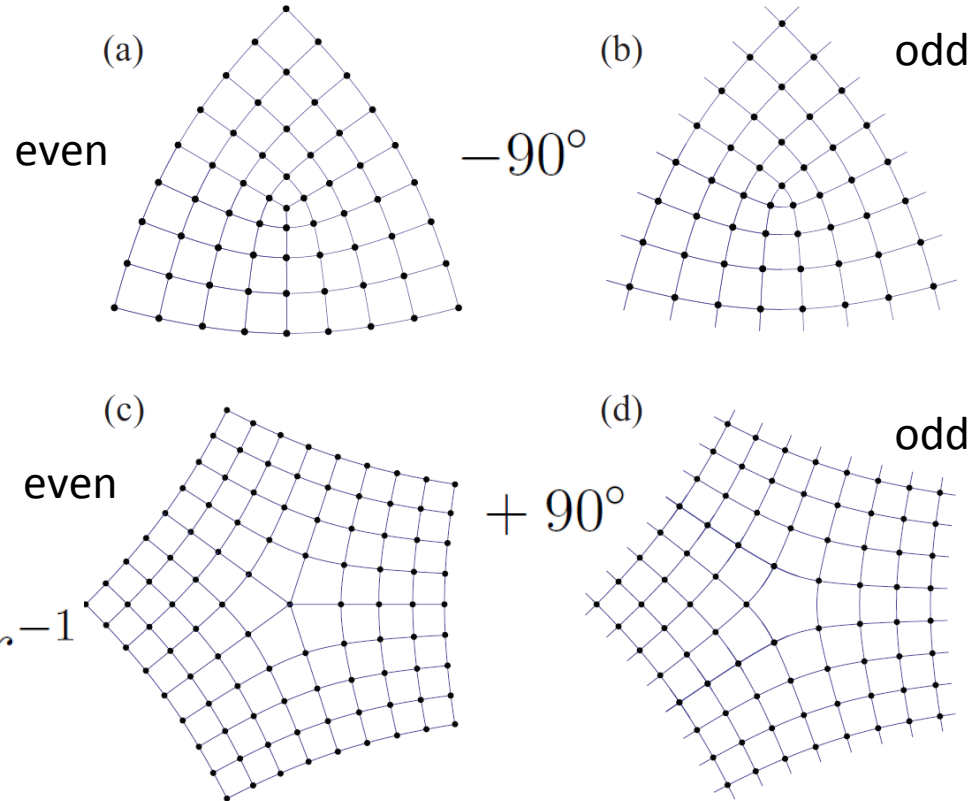

Classification:  $C_4 \times \mathbb{Z}_2$  Frank Angle x Translation Parity



Evenness / oddness of number of translations.  
Equal to number of distinct rotation centers.

# Dislocation = Disclination Dipole

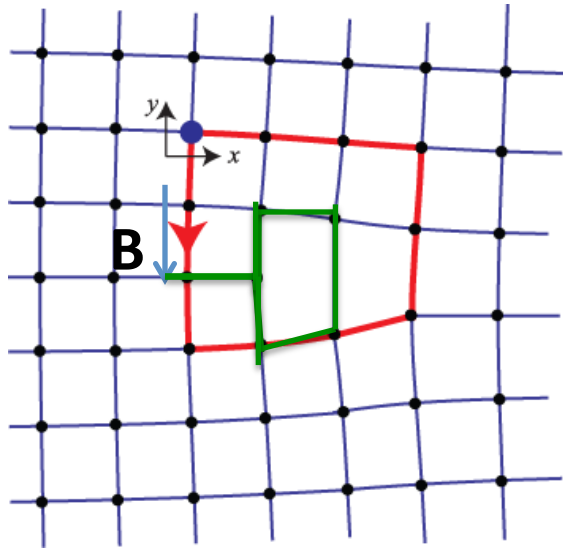

Overall odd dislocation

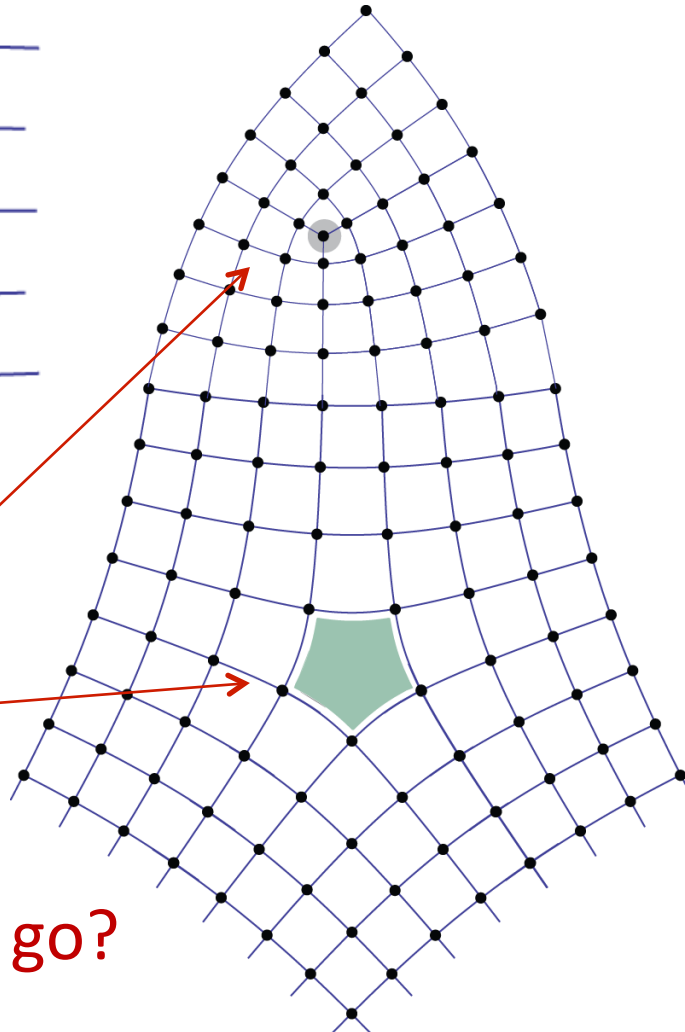

How does  
Majorana mode  
decide where to go?

# Classification of C4 Invariant 2D Superconductors

- BdG Hamiltonian in class D (PHS)

$$\Xi H_{BdG}(\mathbf{k}) \Xi^{-1} = -H_{BdG}(-\mathbf{k})$$

- C4 rotation symmetry (square lattice)

$$\hat{r} H_{BdG}(\mathbf{k}) \hat{r}^\dagger = H_{BdG}(r \cdot \mathbf{k})$$

$$\Xi \hat{r} \Xi^{-1} = \hat{r}$$

$$\hat{r}^4 = -1$$

# Classification of C4 Symmetric Superconductors

- Topological invariants (all T-breaking)

(i) First Chern Number  $ch = \frac{i}{2\pi} \int_{BZ} \text{Tr}(d\mathcal{A})$

(ii) Rotation invariants

4-fold momenta rotation eigenvalues

at  $\Pi = \Gamma, M$

$$\Pi_5 = e^{-i\pi/4}, \quad \Pi_6 = e^{i\pi/4}$$

$$\Pi_7 = e^{i3\pi/4}, \quad \Pi_8 = e^{-i3\pi/4}$$

2-fold momenta rotation eigenvalues

$$X_3 = i, \quad X_4 = -i$$

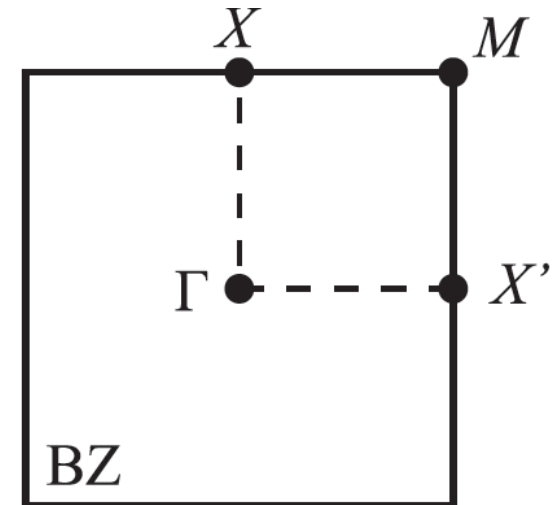

Rotation spectra discrepancies in *valence* bands

$$n_4 = \#X_4 - \#\Gamma_5 - \#\Gamma_7$$

$$n_6 = \#M_6 - \#\Gamma_6 \quad n_7 = \#M_7 - \#\Gamma_7$$

$$K = \mathbb{Z}^4$$

# Hamiltonian Generators

- 4 group generators / model Hamiltonians for

$$\mathbb{Z}^4 = \{(ch; n_4, n_6, n_7)\}$$

(i) **Modified chiral p+ip superconductor on square lattice**

$$H_a = \Delta(\sin k_x \tau_x + \sin k_y \tau_y) + u_1(\cos k_x + \cos k_y) \tau_z + 2u_2 \cos k_x \cos k_y \tau_z$$

$H_a$	hopping strength	$ch$	$n_4$	$n_6$	$n_7$
$H_a^{(1;0)}$	$u_1 > u_2 > 0$	1	-1	1	0
$H_a^{(1;1)}$	$-u_1 > u_2 > 0$	1	0	-1	0

(ii) **Lattice models of Majorana fermions**

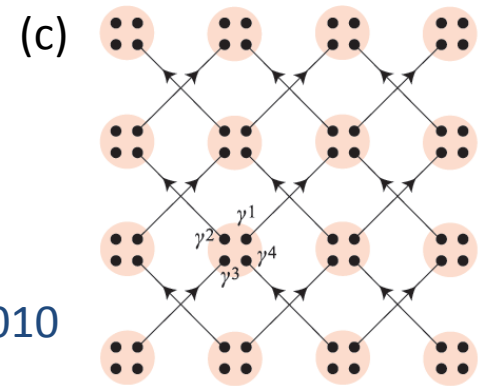
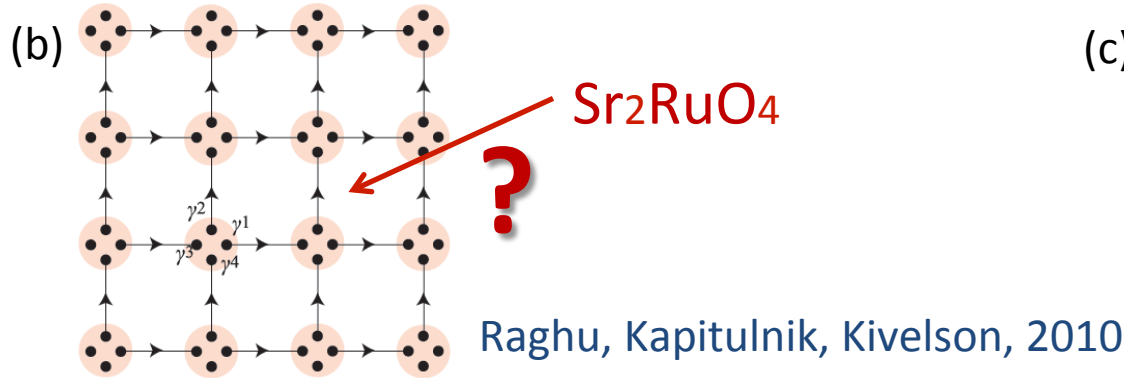

TB model	$ch$	$n_4$	$n_6$	$n_7$
$H_b$	0	1	-1	1
$H_c$	0	2	0	0

# Majorana Zero Modes at Disclinations

- Simple Majorana Models:

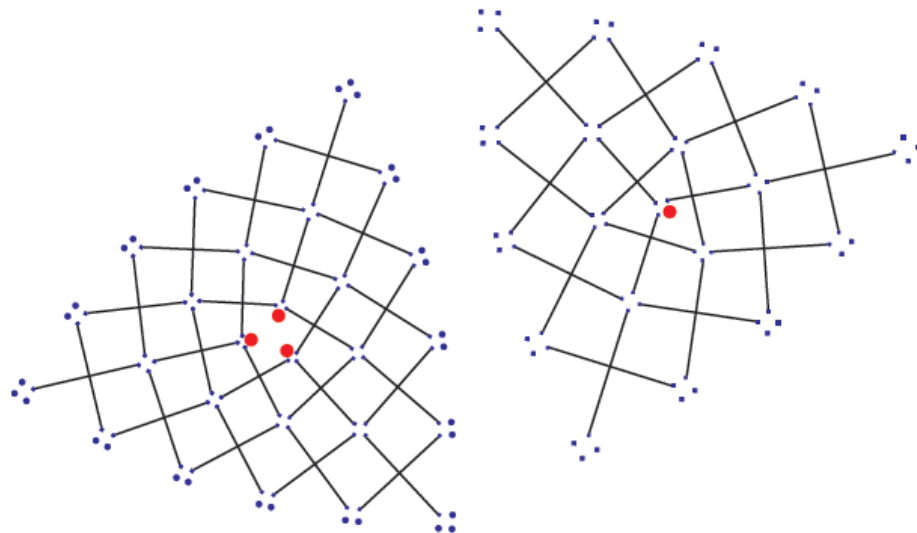
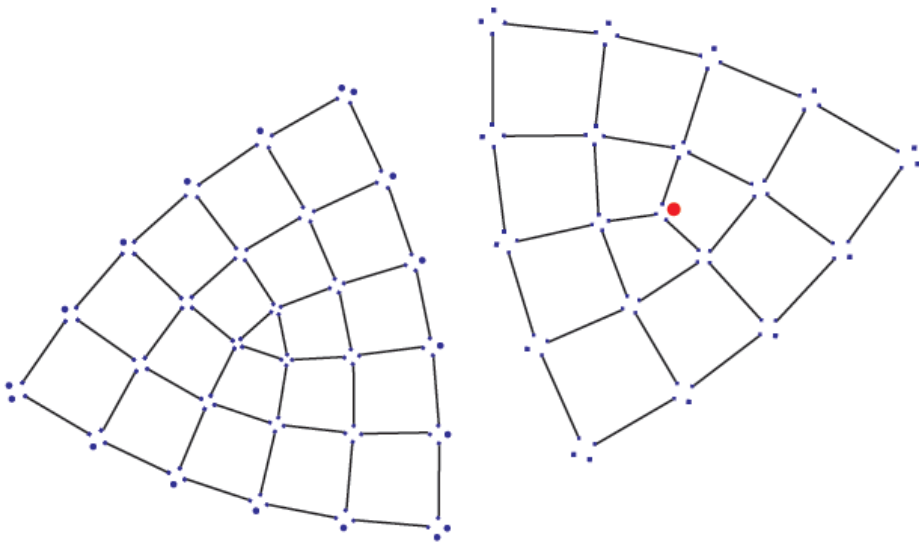
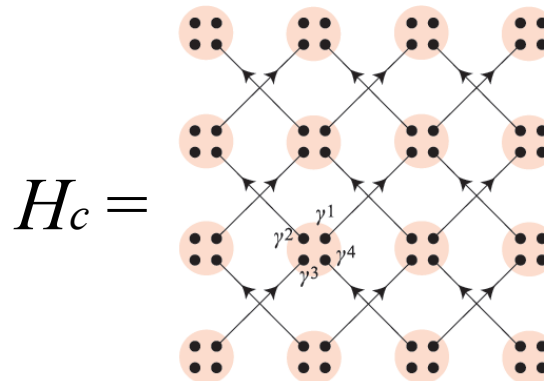
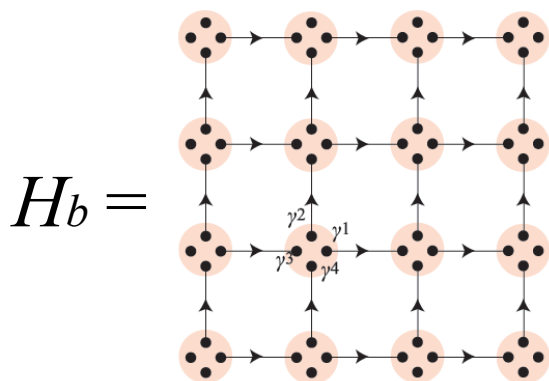



# Z2 Index for MBS on Disclinations

$$\Theta \equiv \left[ \frac{1}{2\pi} \mathbf{T} \cdot \mathbf{G}_\nu + \frac{\Omega}{2\pi} (ch + n_6 + 2n_4 + 3n_7) \right] \text{ mod } 2$$

(a)

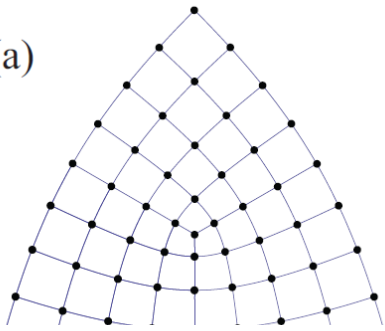

$$\mathbf{T} = 0, \Omega = -\pi/2$$

(d)

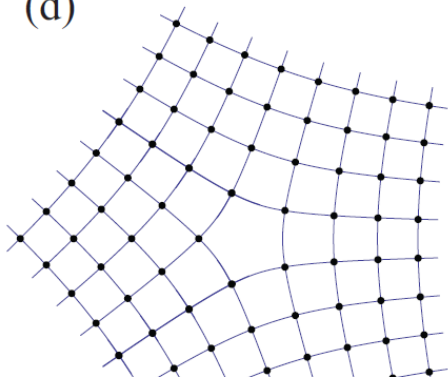

$$\mathbf{T} = 1, \Omega = +\pi/2$$

Frank angle

Rotation invariant  
from occupied bands

Weak invariant

$$\mathbf{G}_\nu = n_4 + n_6 + n_7$$

Chern invariant

# Z2 Index for MBS on Disclinations

$$\Theta \equiv \left[ \frac{1}{2\pi} \mathbf{T} \cdot \mathbf{G}_\nu + \frac{\Omega}{2\pi} (ch + n_6 + 2n_4 + 3n_7) \right] \text{ mod } 2$$

Translation piece

Number of Majorana fermion on an edge

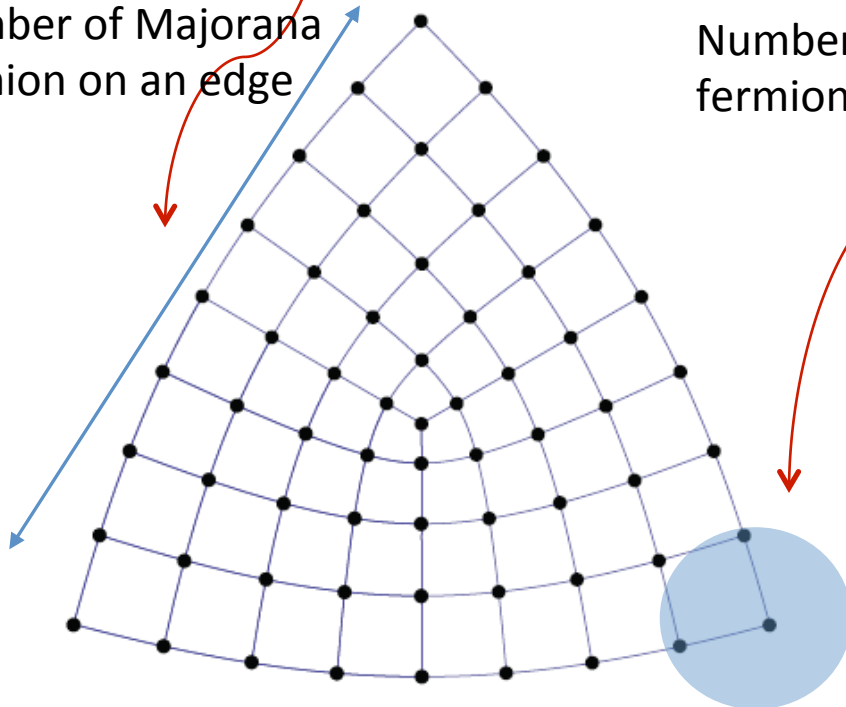

Rotation piece

Number of Majorana fermion at a corner

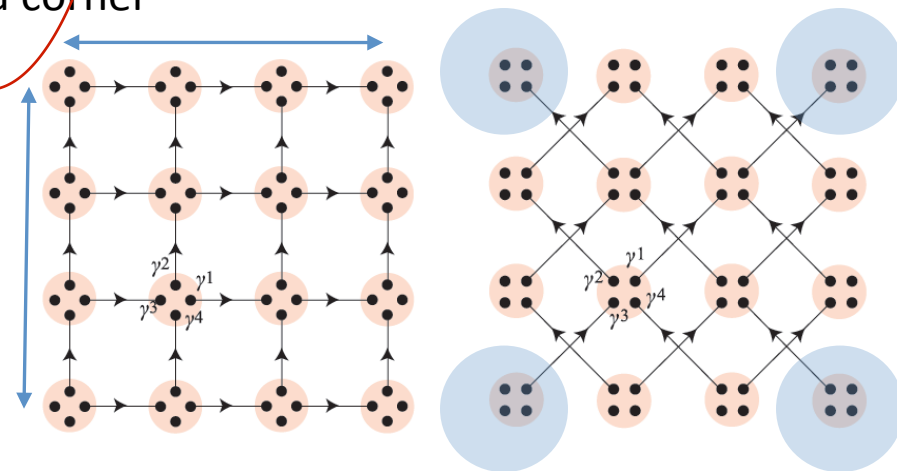

# Part 3: Topological Response of 2+1-D T-breaking Chern Insulator to Geometric Perturbations

# Historical Reference List

## Precursors:

- AVRON, JE, R. SEILER, and PG ZOGRAF. "VISCOSITY OF QUANTUM HALL FLUIDS." *Physical review letters* **75**, 697 (1995)
- Lévy, P ter. "Berry's phase, chaos, and the deformations of Riemann surfaces." *Physical Review E* **56**, 6173 (1997).
- Avron, J. E. "Odd viscosity." *Journal of statistical physics* **92**, 543 (1998).

## Modern Developments

- Read, N. "Non-Abelian adiabatic statistics and Hall viscosity in quantum Hall states and  $p_x + ip_y$  paired superfluids." *Physical Review B* **79**, 045308 (2009).
- Haldane, F. D. M. "Hall viscosity and intrinsic metric of incompressible fractional Hall fluids." *arXiv:0906.1854*.
- Tokatly, I. V., and Giovanni Vignale. "Lorentz shear modulus of fractional quantum Hall states." *Journal of Physics: Condensed Matter* **21.27** (2009): 275603.
- Hughes, Taylor L., Robert G. Leigh, and Eduardo Fradkin. "Torsional response and dissipationless viscosity in topological insulators." *Physical Review Letters* **107**, 075502 (2011).
- Read, N., and E. H. Rezayi. "Hall viscosity, orbital spin, and geometry: paired superfluids and quantum Hall systems." *Physical Review B* **84** 085316 (2011).
- Barkeshli, Maissam, Suk Bum Chung, and Xiao-Liang Qi. "Dissipationless phonon Hall viscosity." *Phys Rev B* **85** (2012): 245107.
- Bradlyn, Barry, Moshe Goldstein, and N. Read. "Kubo formulas for viscosity: Hall viscosity, Ward identities, and the relation with conductivity." *Physical Review B* **86**, 245309 (2012).
- Hoyos, C., and D. T. Son. "Hall viscosity and electromagnetic response." *Physical review letters* **108**, 066805 (2012).
- Ryu, Shinsei, Joel E. Moore, and Andreas WW Ludwig. "Electromagnetic and gravitational responses and anomalies in topological insulators and superconductors." *Physical Review B* **85**, 045104 (2012).
- M Stone, "Gravitational anomalies and thermal Hall effect in topological insulators." *Phys Rev B* **85**, 184503 (2012).
- Hughes, Taylor L., Robert G. Leigh, and Onkar Parrikar. "Torsional Anomalies, Hall Viscosity, and Bulk-boundary Correspondence in Topological States." *Phys. Rev. D* **88**, 025040 (2013).
- Abanov, Alexander G. "On the effective hydrodynamics of the fractional quantum Hall effect." *J Phys A*, **46**, 292001 (2013).
- Wiegmann, P. "Anomalous Hydrodynamics of Fractional Quantum Hall States." *arXiv:1305.6893*.

# Geometry Coupling in Solids via Frame Field

Conventionally, electrons moving in a solid couple to “geometry” through the local displacement field which encodes distances between unit cells via the strain/metric tensor.

$$g^{ij} = \delta^{ij} - 2u^{ij} \quad u^{ij} = \frac{1}{2} \left( \frac{\partial u^i}{\partial x_j} + \frac{\partial u^j}{\partial x_i} \right)$$

If the unit cells are featureless and isotropic then it is just the distance between cells that determines the hopping matrix elements which feed back into the electronic structure.

However, the orientation of the local degrees of freedom (orbitals/spin) within the unit cell can also be important for the resulting electronic structure and require the introduction of a frame field.

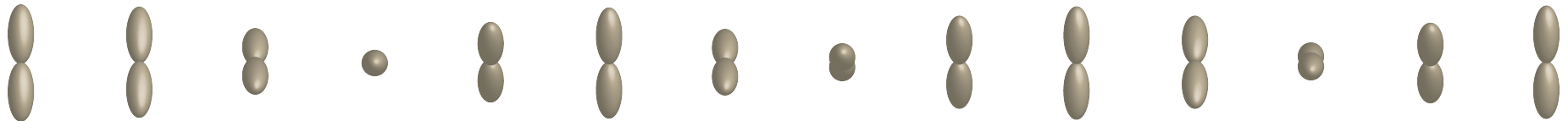

$$e_a^i = \delta_a^i - \frac{\partial u_a}{\partial x_i}$$

$$g^{ij} = e_a^i \delta^{ab} e_b^j$$

The strain/metric tensor represents an equivalence class of frames which can differ by LOCAL rotations. Thus, the frame contains more information (“square root of metric”).

# Appearance of Frame Field in Solids

When should we worry about using a frame?

Toy problem: Take two atoms with  $p_x$ ,  $p_y$ , and  $p_z$ -orbitals. Does the energy depend on how the orbitals are locally oriented on each site?

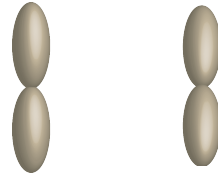

SOC=0

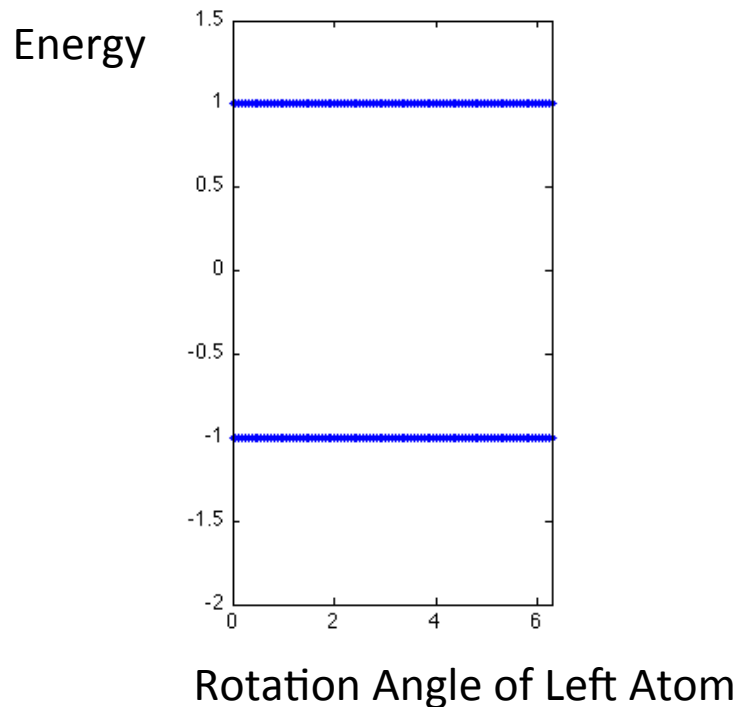

# Appearance of Frame Fields in Solids

The place to look for the effects of torsion is in materials which have strong spin-orbit coupling. This means that you want the motion/momentum coupled to spin degrees of freedom:

$$H = p_i e_a^i \Gamma^a + m \Gamma^0 \quad \text{Dirac model/Topological Insulator}$$

$$H = p_i p_j e_a^i e_b^j S^a S^b \quad \text{Luttinger model for common III-V semi-conductors (spin 3/2)}$$

However, simple Schrodinger electrons won't even feel the effects:

$$H = \frac{p_i e_a^i \delta^{ab} e_b^j p_j}{2m} = \frac{p_i g^{ij} p_j}{2m}$$

# U(1) analogy for frame fields: Gauge field of translations

Gauge potential and Wilson loop for electro-magnetic field:

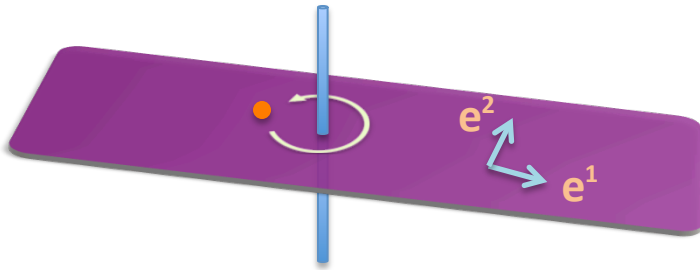

$$\mathbf{B} = \nabla \times \mathbf{A}$$

$$U = \exp \left[ \frac{ie}{\hbar} \oint \mathbf{A} \cdot d\mathbf{l} \right] = \exp [2\pi i \Phi / \Phi_0]$$

Gauge potential and Wilson loop for dislocations:

$$\mathcal{B}^a = \nabla \times \mathbf{e}^a$$

$$U = \exp \left[ \frac{ip_a}{\hbar} \oint \mathbf{e}^a \cdot d\mathbf{l} \right] = \exp \left[ -\frac{i}{\hbar} p_a b^a \right]$$

Magnetic Flux of frame field is a dislocation





# Calculating Geometric Response

We will be considering 2+1-d massive fermions (Chern Insulator/QAHE) coupled to external geometric perturbations. We can just integrate out the fermions:

$$S = \int d^3x \det(e) \bar{\psi} (iD_\mu e_a^\mu \gamma^a - m) \psi$$

$$D_\mu = \partial_\mu - i\omega_{\mu ab} \Sigma^{ab}$$

Stress Tensor response:

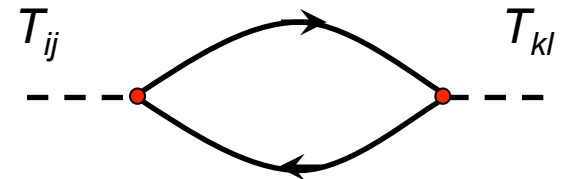

We find:

$$S_{eff}[A, e, \omega] =$$

$$\frac{1}{2} \int \left( \sigma_H A \wedge dA - \frac{2\Lambda}{\kappa_N} \text{vol}_M + i\kappa_H CS[\hat{\omega}] + i\zeta_H e^a \wedge T_a + \frac{1}{\kappa_N} \epsilon_{abc} e^a \wedge \mathring{R}^{bc} + \dots \right)$$

# Chiral Gravity Response Theory

- Keeping T-even and T-odd pieces we find an interesting structure:

$$\frac{1}{2} \int \left( \sigma_H A \wedge dA - \frac{2\Lambda}{\kappa_N} \text{vol}_M + i\kappa_H CS[\hat{\omega}] + i\zeta_H e^a \wedge T_a + \frac{1}{\kappa_N} \epsilon_{abc} e^a \wedge \hat{R}^{bc} + \dots \right)$$

Topological Phase

$$\zeta_H = \frac{m^2}{2\pi}$$

$$\sigma_H = \frac{e^2}{8\pi}$$

$$\kappa_H = \frac{h}{4\pi}$$

$$\frac{\kappa_H}{\kappa_N} = \frac{1}{48\pi}$$

$$\frac{\kappa_H}{\kappa_N} = \frac{|m|}{12\pi}$$

$$\frac{\Lambda}{\kappa_N} = \frac{\Lambda_0}{3\pi}$$

$$\frac{\Lambda}{\kappa_N} = \frac{\Lambda_0}{3\pi} - \frac{1}{3\pi} |m|^3$$

Can rewrite in a Chern-Simons term using a single  $SL(2, \mathbb{R})$  connection (Witten 1989, 2007)

$$A^a = \omega^a + \frac{1}{\ell} e^a$$

$$\ell = \frac{1}{2m}$$

Coefficients in topological phase satisfy Brown-Henneaux formula with

$$c_L = 0, c_R = 1$$

# Chiral Gravity Response Theory

- Keeping T-even and T-odd pieces we find an interesting structure:

$$\frac{1}{2} \int \left( \sigma_H A \wedge dA - \frac{2\Lambda}{\kappa_N} \text{vol}_M + i\kappa_H CS[\hat{\omega}] + i\zeta_H e^a \wedge T_a + \frac{1}{\kappa_N} \epsilon_{abc} e^a \wedge \mathring{R}^{bc} + \dots \right)$$

Topological Phase

$$\zeta_H = -\frac{m^2}{2\pi}$$

$$\sigma_H = -\frac{e^2}{h}$$

$$\kappa_H = -\frac{1}{48\pi}$$

$$\frac{1}{\kappa_N} = \frac{|m|}{12\pi}$$

$$\frac{\Lambda}{\kappa_N} = \Lambda_0^3 - \frac{1}{3\pi} |m|^3$$

We also find a subleading correction to the viscosity which is quantized in units of  $C_1/48\pi$

$$\frac{1}{2} \int_M \kappa_H \mathring{R}e^A \wedge T_A$$

On a constant curvature Riemann manifold

$$\zeta_H = - \left( \frac{m^2}{2\pi} - \frac{(g-1)}{6A} \right) = -\mathcal{S}$$

# Topological Viscosity

- We will only look at the torsion term and to simplify the description we focus on a flat background where we pick a gauge where the spin-connection vanishes:

$$S_{eff} = \frac{1}{2} \eta_3 \int d^3 x \epsilon^{\mu\nu\rho} e_\mu^a \partial_\nu e_\rho^b \eta_{ab}$$

We can compare this to the quantum Hall response:

$$S_{eff}[A_\mu] = \frac{n}{4\pi} \int d^3 x \epsilon^{\mu\nu\rho} A_\mu \partial_\nu A_\rho$$

Note that the coefficient of the first term must have units of  $1/[\text{Length}]^2$  when compared to the dimensionless, quantized Hall conductance. If we reinsert the physical units into the frame field response we find:

$$\eta_3 = \frac{\hbar}{2\pi} \left( \frac{m}{\hbar v} \right)^2 \equiv \frac{\hbar}{8\pi \ell^2}$$

# Topological Viscosity Response Equations

- We can calculate the stress-energy tensor and find:

$$T_a^i = \eta_3 \epsilon^{ij} (\partial_j e_0^b - \partial_0 e_j^b) \eta_{ab} \equiv \eta_3 \epsilon^{ij} \mathcal{E}_j^b \eta_{ab}$$

$$T_a^0 = \eta_3 \epsilon^{ij} \partial_i e_j^b \eta_{ab} \equiv \eta_3 \mathcal{B}^b \eta_{ab}$$

$$j^i = \frac{ne^2}{h} \epsilon^{ij} E_j$$

$$j^0 = \frac{ne^2}{h} B$$

Torsion Magnetic Field:

$$\mathcal{B}^a = - \sum_i b_{(i)}^a \delta(\mathbf{x} - \mathbf{x}_{(i)})$$

The torsion magnetic field is simply tied to the dislocation density.  
(Also curvature magnetic field tied to disclinations)

# Magnetic Torsion Response

$$T_a^0 = \eta_3 \epsilon^{ij} \partial_i e_j^b \eta_{ab} \equiv \eta_3 \mathcal{B}^b \eta_{ab}$$

This torsion response implies that momentum *density* in the *a*-th direction is bound to a frame field flux *i.e.* a dislocation

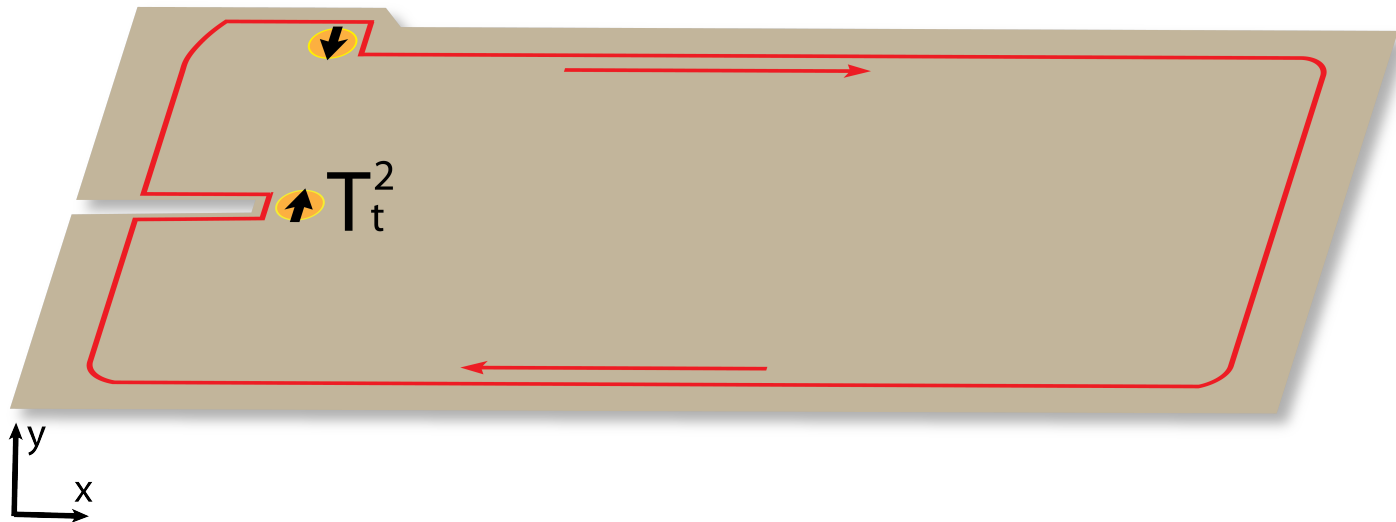

Momentum density on dislocation is (momentum/length)\*length of edge state pushed into bulk. That is viscosity\*Burgers' vector.

# Magnetic Torsion Response

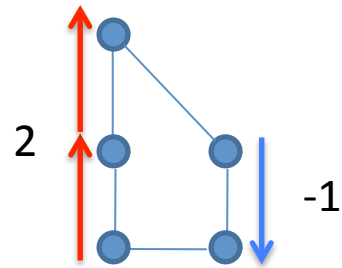
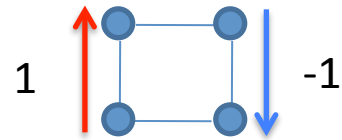
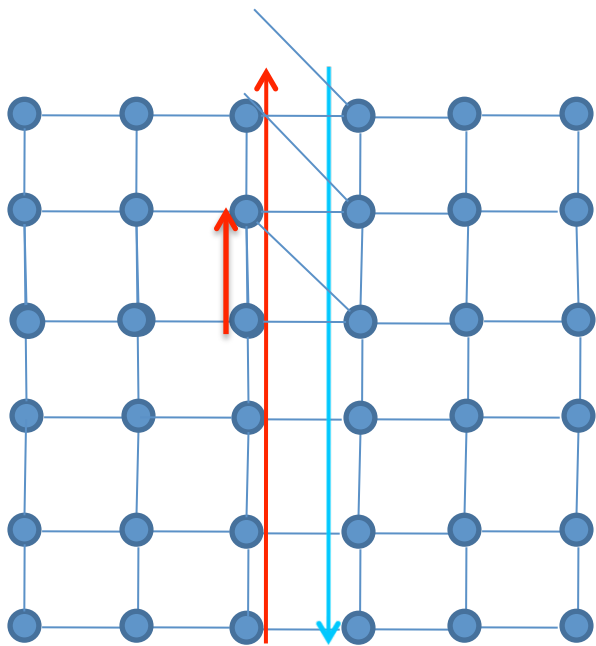



# Electric Charge Response

Before we tackle the electric torsion response let us first consider the electric field response in the QHE: Generate E-field via the Faraday effect

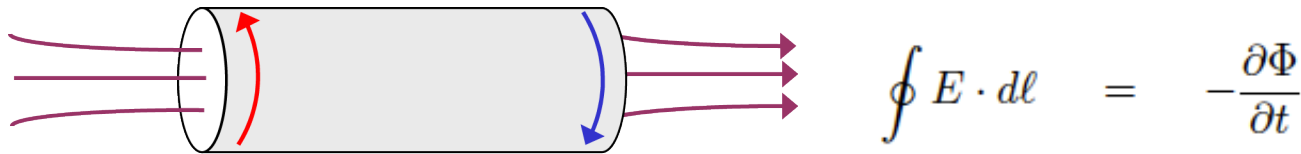

# Electric Charge Response

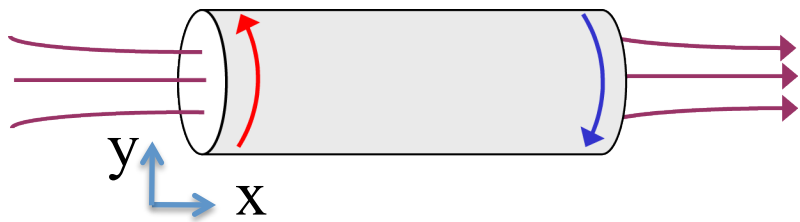

$$\begin{aligned}
 p_y &\rightarrow p_y + e\Delta A_y \\
 &= \hbar \frac{2\pi q}{L} + e \frac{h}{eL} = \hbar \frac{2\pi(q+1)}{L}
 \end{aligned}$$

Spectral Flow of the Edge States

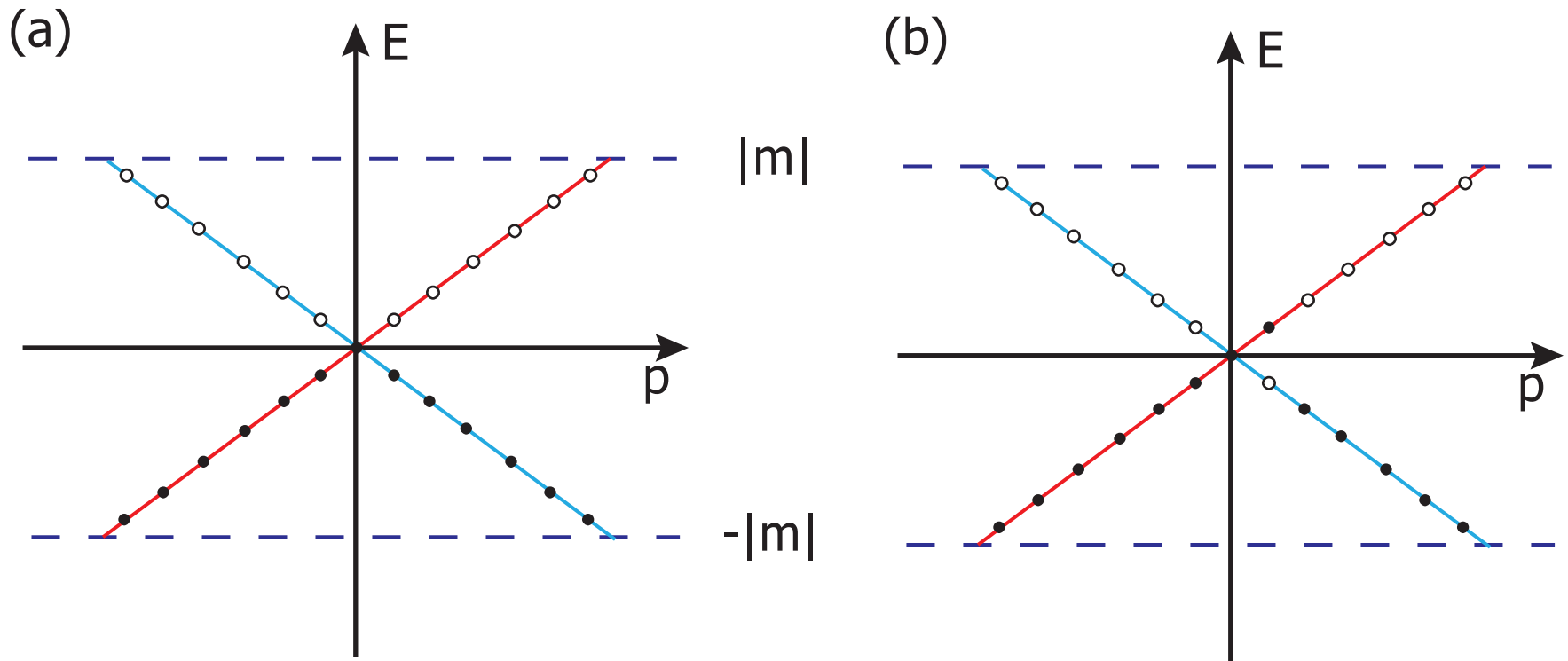

# Electric Torsion Response

$$T_a^i = \eta_3 \epsilon^{ij} (\partial_j e_0^b - \partial_0 e_j^b) \eta_{ab} \equiv \eta_3 \epsilon^{ij} \mathcal{E}_j^b \eta_{ab}$$

Thread a torsion flux through the cylinder *i.e.* thread a dislocation.

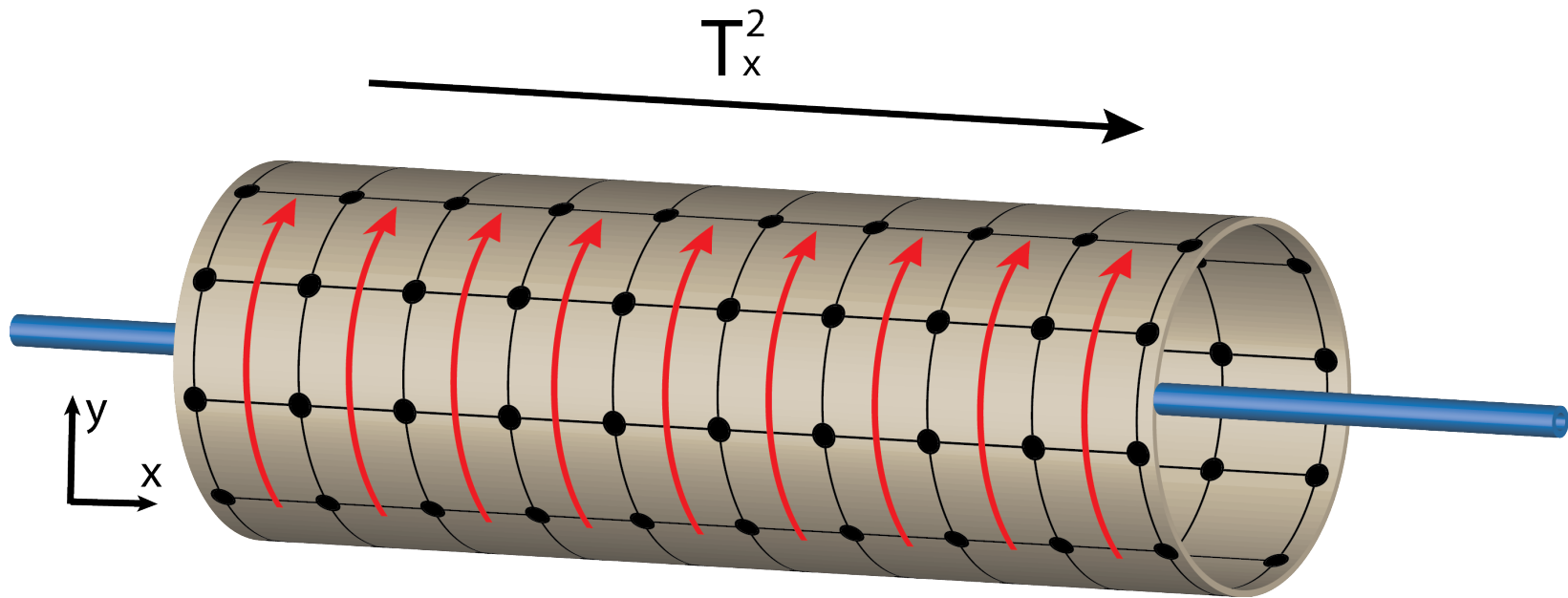

# QH Viscosity Bulk Boundary Correspondence

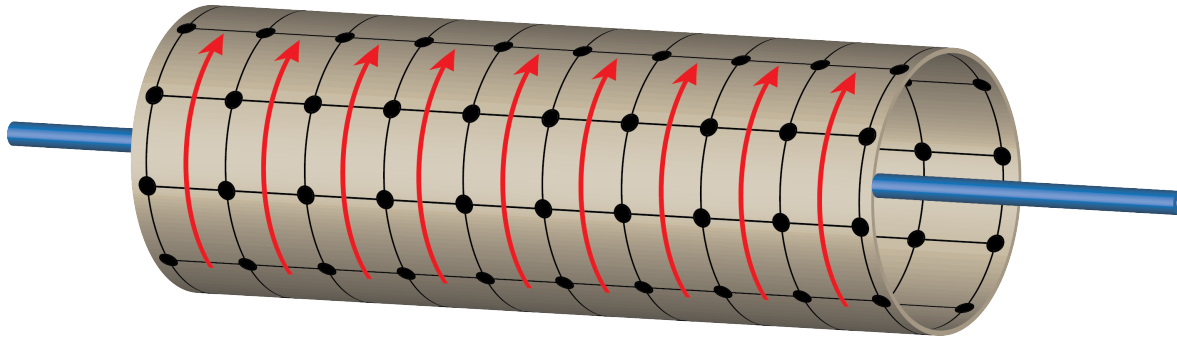

A new 1+1-d anomaly in the stress current (Diffeomorphism anomaly)

$$\epsilon^{\mu\nu} \partial_\mu J_\nu^a \sim \epsilon^{\mu\nu} T_{\mu\nu}^a$$

$$p_i \rightarrow p_a + p_i h_a^i$$

$$e_a^i = \delta_a^i + h_a^i$$

Comparison with chiral current:

$$\partial_\mu \epsilon^{\mu\nu} j_\nu = \partial_\mu j_5^\mu \sim \epsilon^{\mu\nu} F_{\mu\nu}$$

$$p_i \rightarrow p_i + e A_i$$

How do we understand spectral flow?

# QH Viscosity Bulk Boundary Correspondence

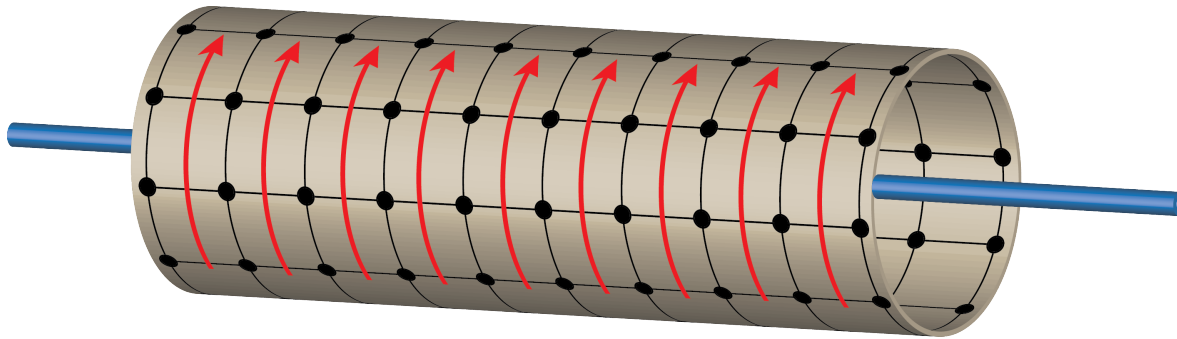

Can get some clues from twisted boundary conditions:

$$\begin{aligned}
 \Psi_p(y + L_y) &= \exp[ik_y \theta(t)] \Psi_p(y) \\
 e^{ik_y L_y} \Psi_p(y) &= \exp[ik_y b^y(t)] \Psi_p(y) \\
 k_y &= \frac{2\pi}{L_y} \left[ \frac{1}{1 - b(t)/L_y} \right] \\
 \nu_y &= \frac{q}{L_y} \left( \frac{q}{1 - \Phi_0} \right)
 \end{aligned}$$

(perform gauge transformation)

# QH Viscosity Bulk Boundary Correspondence

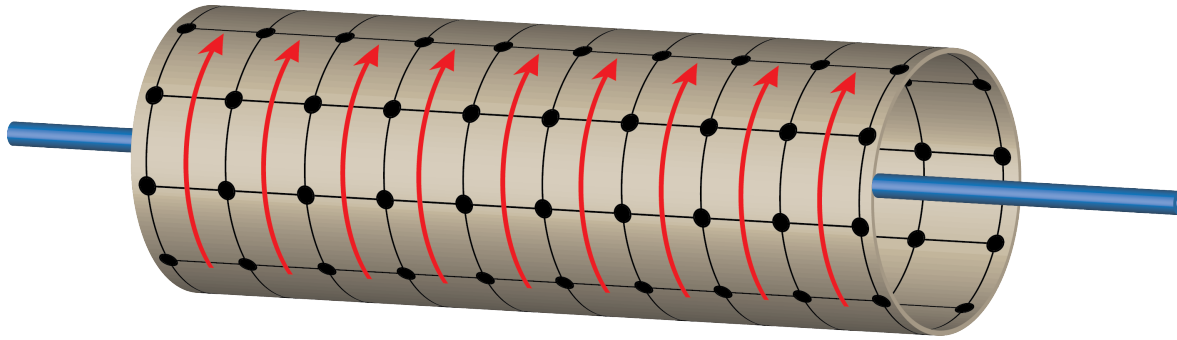

Spectral Flow:

$$\kappa_y^{L/R} = \frac{2\pi}{L_y} \left[ q + \frac{\Phi(t)}{\Phi_0} \right] \quad (\text{Hall conductance due to shift})$$

$$\kappa_y^{L/R} = \frac{2\pi q}{L_y} \left[ \frac{1}{1 \pm b(t)/L_y} \right] \quad (\text{Viscosity due to scaling?})$$

Can think about it like fixed velocity but changing length of edge,  
OR fixed length but edge velocities changing

# Spectral Stretching/Rotation

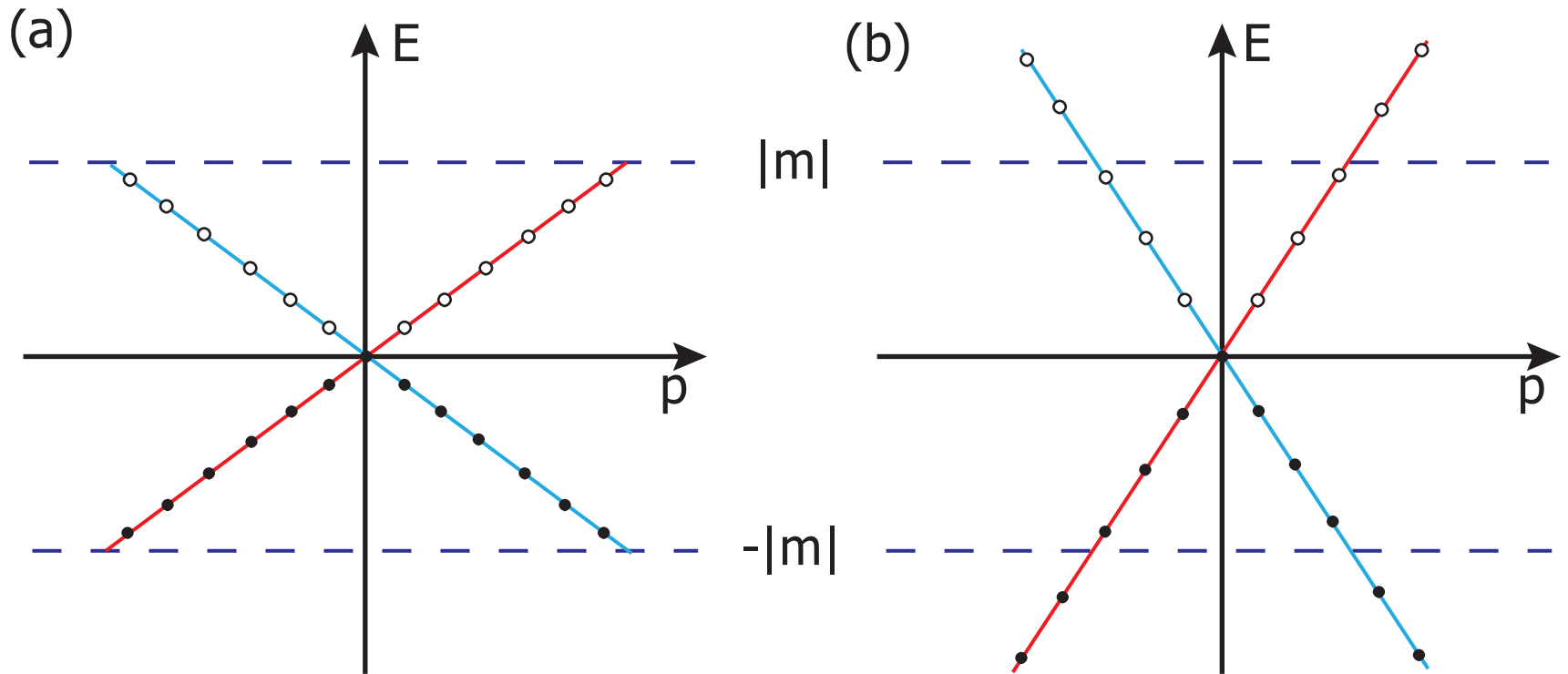

The cut-off breaks Lorentz invariance explicitly at high energy. Similar to how lattice Chern insulator has broken time-reversal (or parity in original language) at high energy.

Momentum transport during velocity changing process/diffeomorphism exactly matches bulk viscosity transport from the torsion Chern-Simons.

# Spectral Flow Comparison

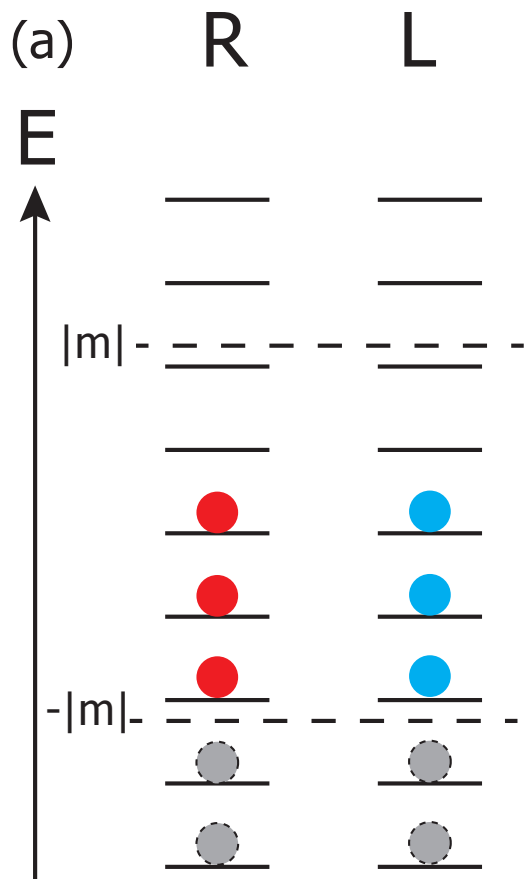

(unmodified)

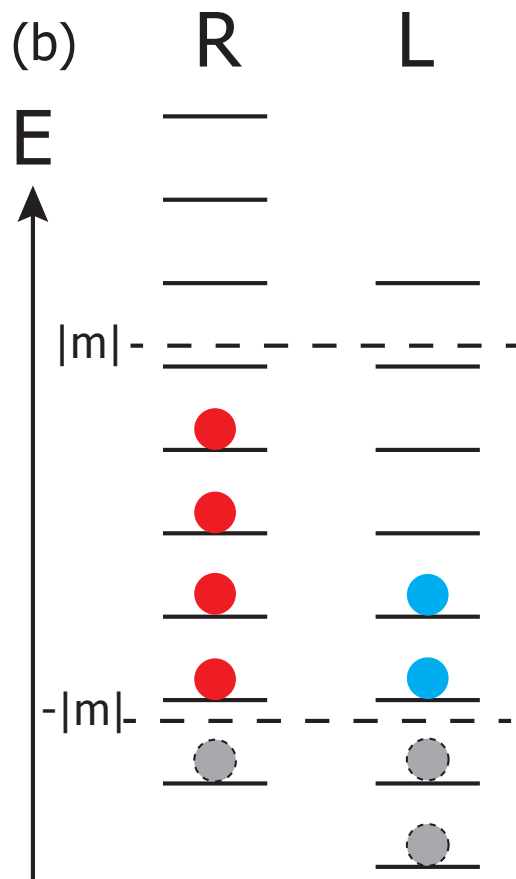

(Electromagnetic)

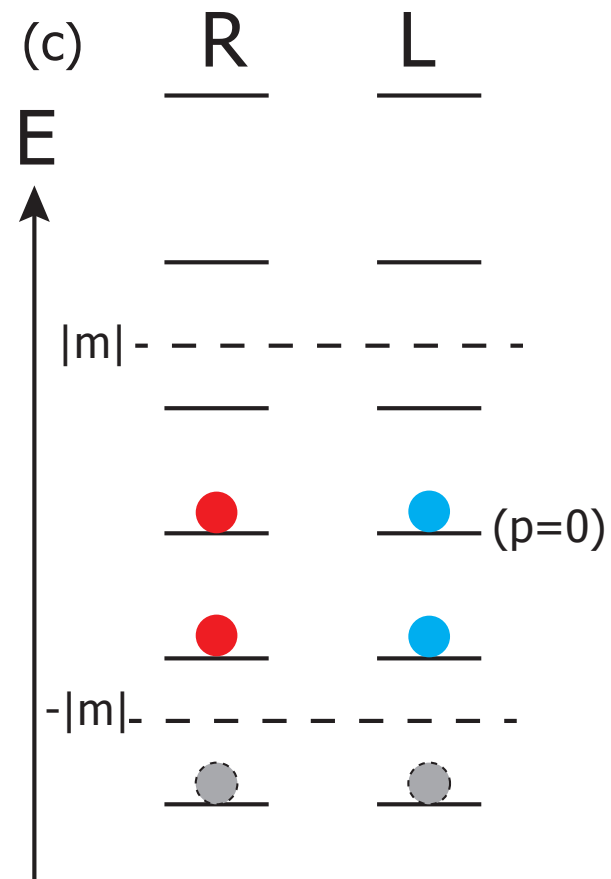

(Torsion)



# Summary

We discussed types of topological phases protected by discrete spatial symmetries and their corresponding responses and tendency to bind low-energy states to defects.

We also discussed the appearance of a chiral gravity response theory in the 2+1-d Chern insulator and the corresponding viscosity response including a new type of edge anomaly.

